

SSM2250

FEATURES

Part of SoundMax® Audio Solution for Desktop Computers
Mono 1.5 W Differential or Stereo 250 mW Output
Single-Supply Operation: 2.7 V to 6 V
Low Shutdown Current = 60 μ A
PC 99 Compliant
Low Distortion: 0.2% THD at 1.5 W
Wide Bandwidth: 4 MHz
Unity-Gain Stable

APPLICATIONS

Desktop, Portable or Palmtop Computers
 Sound Cards
 Communication Headsets
 2-Way Communications
 Handheld Games

GENERAL DESCRIPTION

The SSM2250 is intended for use in desktop computers that have basic audio functions. It is also ideal for any audio system that needs to provide both an internal monaural speaker and a stereo line or headphone output. Combined with an AC'97 Codec it provides a PC audio system that meets the PC 99 requirements. The SSM2250 is compact and requires a minimum of external components.

The SSM2250 features an audio amplifier capable of delivering 1.5 W of low distortion power into a mono 4 Ω bridged-tied load (BTL) or 2 \times 90 mW into stereo 32 Ω single-ended load (SE) headphones. Both amplifiers provide rail-to-rail outputs for maximum dynamic range from a single supply. The balanced output provides maximum output from 5 V supply and eliminates the need for a coupling capacitor.

The SSM2250 can automatically switch between an internal mono speaker and external headphones. The device can run from a single supply, ranging from 2.7 V to 6 V, with an active supply current of 9 mA typical. The ability to shut down the amplifiers, (60 μ A shutdown current) makes the SSM2250 an ideal speaker amplifier for battery-powered applications.

The SSM2250 is specified over the industrial (-40°C to $+85^{\circ}\text{C}$) temperature range. It is available in 14-lead TSSOP and 10-lead MSOP surface mount packages.

PIN CONFIGURATIONS

10-Lead MSOP
(RM Suffix)

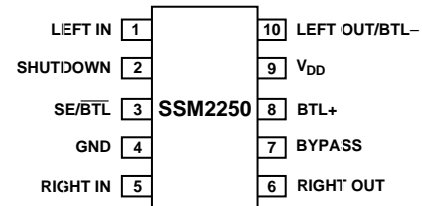

14-Lead TSSOP
(RU Suffix)

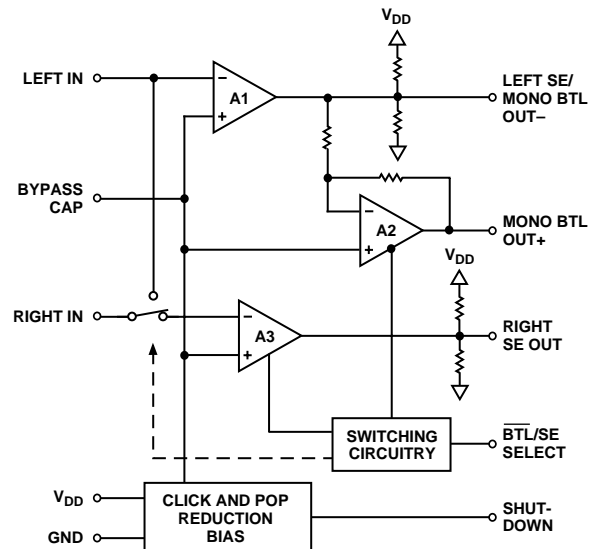
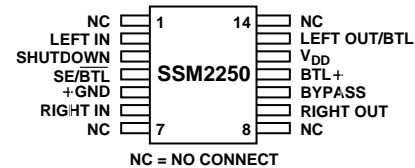

Figure 1. Functional Block Diagram

SoundMax is a registered trademark of Analog Devices, Inc.

REV. 0

Information furnished by Analog Devices is believed to be accurate and reliable. However, no responsibility is assumed by Analog Devices for its use, nor for any infringements of patents or other rights of third parties which may result from its use. No license is granted by implication or otherwise under any patent or patent rights of Analog Devices.

SSM2250—SPECIFICATIONS

ELECTRICAL CHARACTERISTICS ($V_S = 5.0\text{ V}$, $V_{CM} = 2.5\text{ V}$, $T_A = 25^\circ\text{C}$ unless otherwise noted)

Parameter	Symbol	Conditions	Min	Typ	Max	Unit
DEVICE CHARACTERISTICS						
Output Offset Voltage	V_{OS}	BTL Mode; $A_V = 2$; BTL+ to BTL-		4	100	mV
Large Signal Voltage Gain	A_{VO}	$R_L = 2\text{ k}\Omega$		2		V/mV
Output Power	P_{OUT}	SE Mode: $R_L = 32\ \Omega$, THD < 1%		90		mW
		BTL Mode: $R_L = 8\ \Omega$, THD < 1%		1,000		mW
Output Impedance	Z_{OUT}			0.1		Ω
SHUTDOWN INPUT						
Input Voltage High	V_{IH}	$I_S < 100\ \mu\text{A}$	2.0			V
Input Voltage Low	V_{IL}	$I_S > 1\text{ mA}$			0.8	V
POWER SUPPLY						
Supply Current	I_S	BTL Mode		6.4		mA
		SE Mode		6.4		mA
Supply Current/Amplifier	I_S			60		μA
DYNAMIC PERFORMANCE						
Slew Rate	SR	$R_L = 100\text{ k}\Omega$, $C_L = 50\text{ pF}$		4		V/ μs
Gain Bandwidth Product	GBP			4		MHz
Phase Margin	Φ_o			84		Degrees
NOISE PERFORMANCE						
Voltage Noise Density	e_n	$f = 1\text{ kHz}$		45		$\text{nV}/\sqrt{\text{Hz}}$

Specifications subject to change without notice.

ELECTRICAL CHARACTERISTICS ($V_S = 2.7\text{ V}$, $V_{CM} = 1.35\text{ V}$, $T_A = 25^\circ\text{C}$ unless otherwise noted)

Parameter	Symbol	Conditions	Min	Typ	Max	Unit
DEVICE CHARACTERISTICS						
Output Offset Voltage	V_{OS}	BTL Mode; $A_V = 2$; BTL+ to BTL-		4	100	mV
Large Signal Voltage Gain	A_{VO}	$R_L = 2\text{ k}\Omega$		2		V/mV
Output Power	P_{OUT}	SE Mode: $R_L = 32\ \Omega$, THD < 1%		25		mW
		BTL Mode: $R_L = 8\ \Omega$, THD < 1%		300		mW
Output Impedance	Z_{OUT}			0.1		Ω
SHUTDOWN INPUT						
Input Voltage High	V_{IH}	$I_S < 100\ \mu\text{A}$	2.0			V
Input Voltage Low	V_{IL}	$I_S > 1\text{ mA}$			0.8	V
POWER SUPPLY						
Supply Current	I_S	BTL Mode		6.4		mA
		SE Mode		6.4		mA
Supply Current/Amplifier	I_S			32		μA
DYNAMIC PERFORMANCE						
Slew Rate	SR	$R_L = 100\text{ k}\Omega$, $C_L = 50\text{ pF}$		4		V/ μs
Gain Bandwidth Product	GBP			4		MHz
Phase Margin	Φ_o			84		Degrees
NOISE PERFORMANCE						
Voltage Noise Density	e_n	$f = 1\text{ kHz}$		45		$\text{nV}/\sqrt{\text{Hz}}$

Specifications subject to change without notice.

SSM2250

ABSOLUTE MAXIMUM RATINGS¹

Supply Voltage	6 V
Differential Input Voltage	±5 V
Common-Mode Input Voltage	±6 V
ESD Susceptibility	2000 V
Storage Temperature Range	
RM, RU Packages	−65°C to +150°C
Operating Temperature Range	
SSM2250	−40°C to +85°C
Junction Temperature Range	
RM, RU Packages	−65°C to +165°C
Lead Temperature Range (Soldering, 60 sec)	300°C

NOTES

¹Stresses above those listed under Absolute Maximum Ratings may cause permanent damage to the device. This is a stress rating only; functional operation of the device at these or any other conditions above those listed in the operational sections of this specification is not implied. Exposure to absolute maximum rating conditions for extended periods may affect device reliability.

²Differential Input Voltage or $\pm V_S$, whichever is lower.

CAUTION

ESD (electrostatic discharge) sensitive device. Electrostatic charges as high as 4000 V readily accumulate on the human body and test equipment and can discharge without detection. Although the SSM2250 features proprietary ESD protection circuitry, permanent damage may occur on devices subjected to high energy electrostatic discharges. Therefore, proper ESD precautions are recommended to avoid performance degradation or loss of functionality.

Package Type	θ_{JA} ¹	θ_{JC}	Unit
10-Lead MSOP (RM)	200	44	°C/W
14-Lead TSSOP (RU)	180	35	°C/W

NOTE

¹ θ_{JA} is specified for worst-case conditions, i.e., θ_{JA} is specified for device soldered in circuit board for surface mount packages.

ORDERING GUIDE

Model	Temperature Range	Package Description	Package Option
SSM2250RM	−40°C to +85°C	10-Lead MSOP	RM-10
SSM2250RU	−40°C to +85°C	14-Lead TSSOP	RU-14



SSM2250

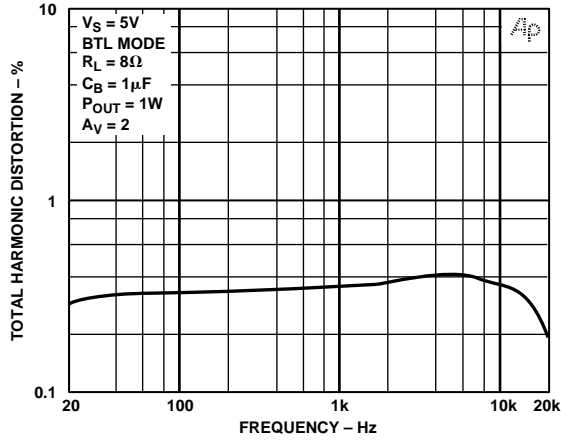

Figure 2. BTL Out THD + N vs. Frequency

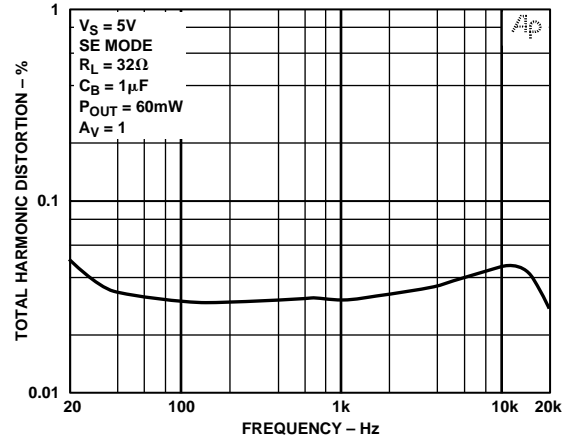

Figure 5. SE Out THD + N vs. Frequency

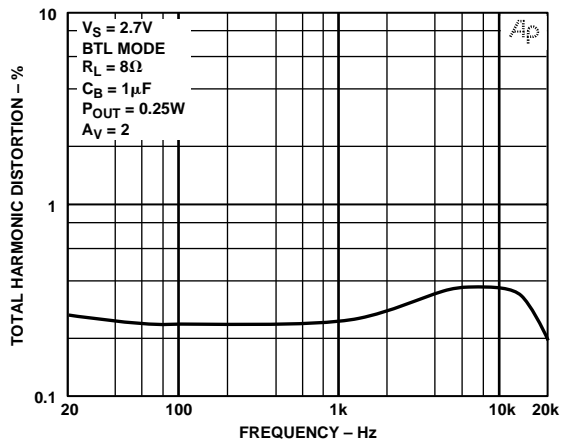

Figure 3. BTL Out THD + N vs. Frequency

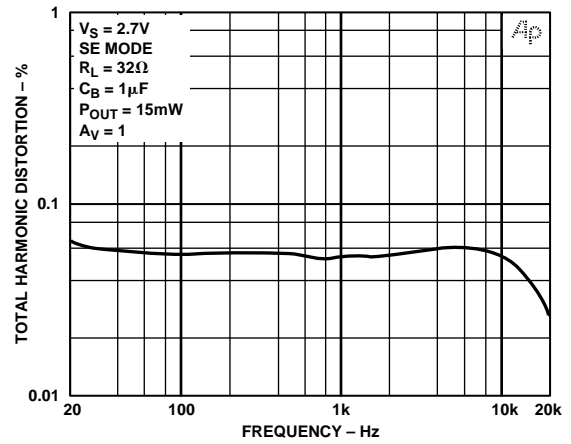

Figure 6. SE Out THD + N vs. Frequency

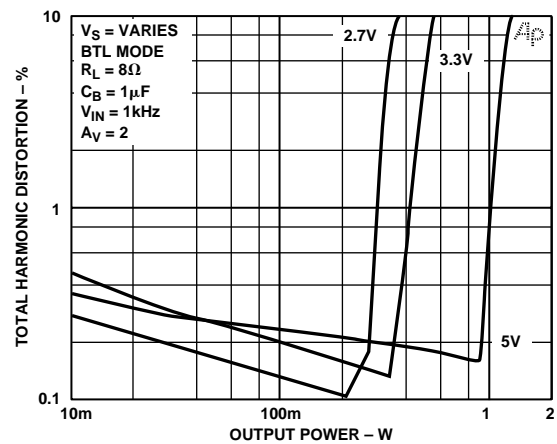

Figure 4. THD + N vs. Output Power

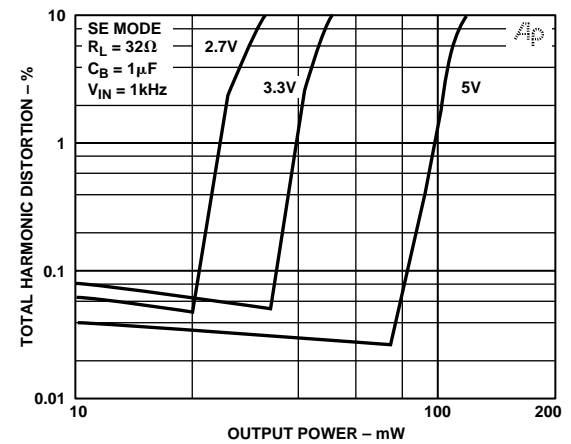

Figure 7. BTL Out THD + N vs. Output Power

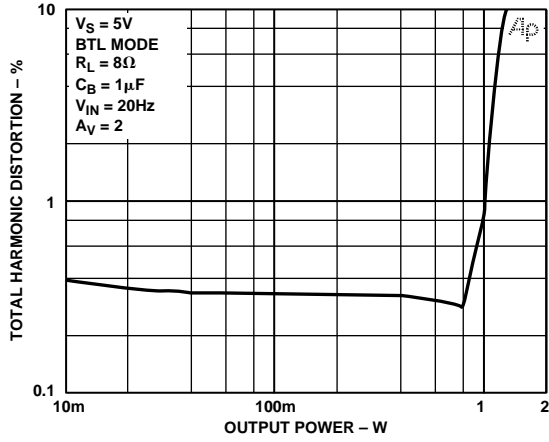

Figure 8. BTL Out THD + N vs. Output Power at 20 Hz

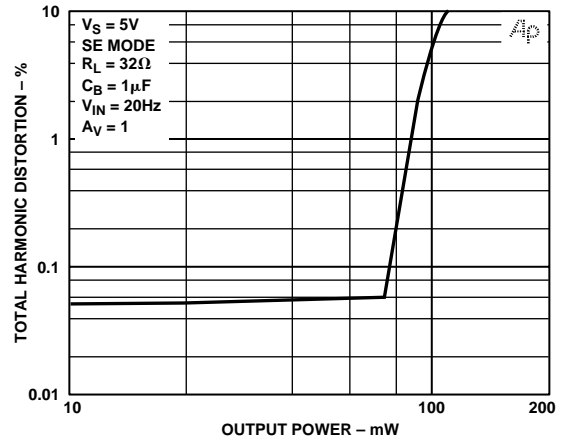

Figure 10. SE Out THD + N vs. Output Power at 20 Hz

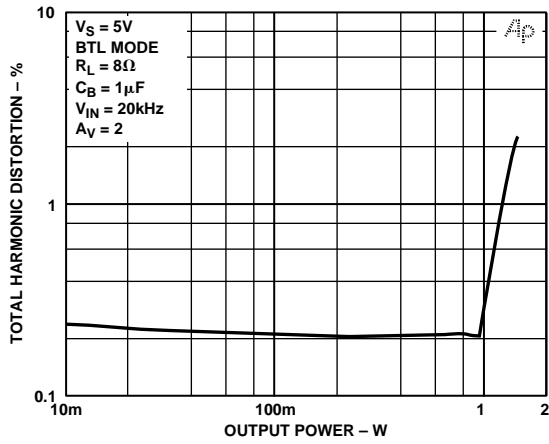

Figure 9. BTL Out THD + N vs. Output Power at 20 kHz

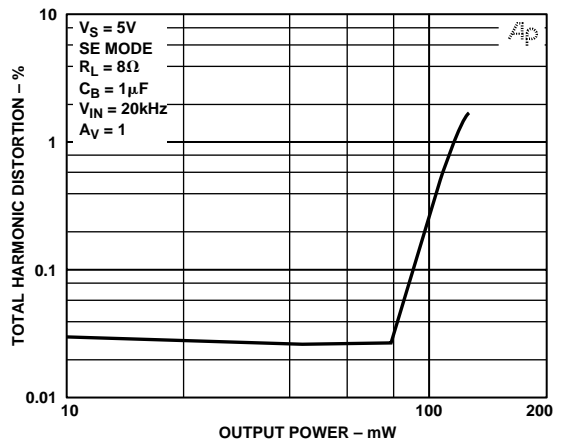

Figure 11. SE Out THD + N vs. Output Power at 20 kHz

SSM2250

PRODUCT OVERVIEW

The SSM2250 is a low distortion power amplifier that can drive a set of stereo headphones or a single 8 Ω loudspeaker. It contains three rail-to-rail output op amps, click and pop reduction biasing, and all necessary switching circuitry. In SE (Single-Ended) Mode, the device automatically mutes the internal 8 Ω speaker. In BTL (Bridge-Tied Load) Mode, the internal speaker is activated.

The SSM2250 can operate from a 2.7 V to 5.5 V single supply. The rail-to-rail outputs can be driven to within 400 mV of either supply rail while supplying a sustained output current of 350 mA into 8 Ω. The device is unity-gain stable and requires no external compensation capacitors. The SSM2250 can be configured for gains of up to 40 dB.

TYPICAL APPLICATION

In SE Mode, the device operates similar to a high current output, dual op amp. A1 and A3 are independent amplifiers with a gain of $-R2/R1$. The outputs of A1 and A3 are used to drive the external headphones plugged into the headphone jack. Amplifier A2 is shut down to a high output impedance state. This prevents current from flowing through the 8 Ω internal speaker, thereby muting it.

Although the gains of A1 and A3 can be set independently, it is recommended that the feedback and feedforward resistor around both amplifiers be equal. This will prevent one channel from becoming louder than the other.

In BTL mode, the current into the Right In pin is directed to the input of A1. This effectively sums the Left and Right In audio signals. The A2 amplifier is activated and configured with a fixed gain of $A_V = -1$. This produces a balanced output configuration that drives the internal speaker. Because the BTL output voltages swing opposite to each other, the gain to the speaker in BTL mode is twice the gain of SE mode. The voltage across the internal speaker can be written:

$$V_{SPEAKER} = (V_{LEFT} + V_{RIGHT}) \times 2 \times \frac{R2}{R1} \quad (1)$$

The bridged output configuration offers the advantage of a more efficient power transfer from the input to the speaker. Because both outputs are symmetric, the dc voltage bias across the 8 Ω internal speaker is zero. This eliminates the need for a coupling capacitor at the output. In BTL mode, the A3 amplifier is shut down to conserve power.

In BTL Mode, the SSM2250 can achieve 1 W continuous output into 8 Ω at ambient temperatures up to 40°C. The power derating curve shown in Figure 15 should be observed for proper operation at higher ambient temperatures. For a standard 14-lead TSSOP package, typical junction-to-ambient temperature thermal resistance (θ_{JA}) is 180°C/W on a 2-layer board, and 140°C/W on a 4-layer board.

Internal Speaker/External Headphones Automatic Switching

Pin 4 on the SSM2250 controls the switching between BTL and SE Modes. Logic low to Pin 4 activates BTL Mode, while logic high activates SE Mode. The configuration shown in Figure 12 provides the appropriate logic voltages to Pin 4, muting the internal speaker when headphones are plugged into the jack.

A stereo headphone jack with a normalizing pin is required for the application. With no plug inserted, a mechanical spring connects the normalizing pin to the output pin in the jack. Once a plug is inserted, this connection is broken.

Referring to Figure 12, Pin 4 of the SSM2250 is connected to the normalizing pin for the right channel output. This is the pin in the headphone jack that will hit the ring on the headphone plug. A 100 kΩ pull-up resistor to 5 V is also connected at this point.

With a headphone plug inserted, the normalizing pin disconnects from the output pin, and Pin 4 is pulled up to 5 V, activating SE Mode on the SSM2250. This mutes the internal speaker while driving the stereo headphones.

Once the headphone plug is removed, the normalizing pin connects to the output pin. This drives the voltage at Pin 4 to 50 mV, as this point is pulled low by the 1 kΩ resistor now connected to the node. The SSM2250 goes into BTL mode, deactivating the right SE amplifier to prevent the occurrence of any false mode switching.

It is important to connect Pin 4 and the 100 kΩ pull up resistor to the normalizing pin for the right output in the headphone jack. Connecting them to the left output normalizing pin will result in improper operation from the device. The normalizing pin to the left output in the headphone jack should be left open.

Coupling Capacitors

Output coupling capacitors are not required to drive the internal speaker from the BTL outputs. However, coupling capacitors are required between the amplifier's SE outputs and the headphone jack to drive external headphones. This prevents dc current from flowing through the headphone speakers, whose resistances are typically on the order of 80 Ω.

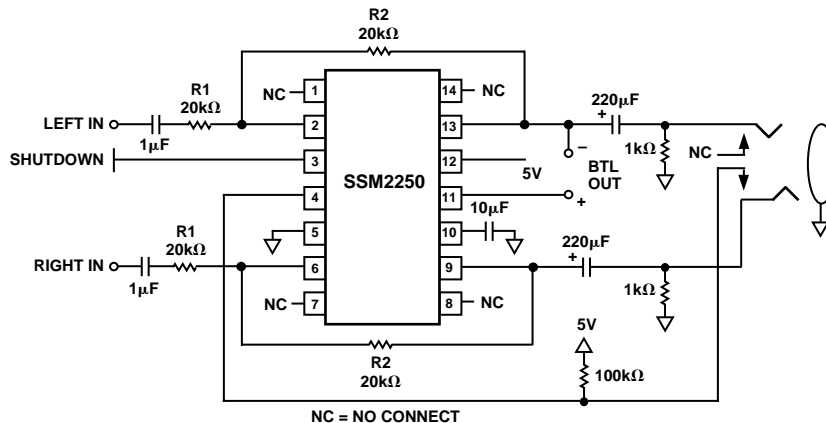

Figure 12. Typical Application

The output coupling capacitor creates a high-pass filter with a cutoff frequency of:

$$f_{-3dB} = \frac{1}{2\pi R_L C_C} \quad (2)$$

Where, R_L is the resistance of the headphone, and C_C is the output coupling capacitor.

Although a majority of headphones have around 80 Ω of resistance, this resistance can vary between models and manufacturers. Headphone resistances are commonly between 32 Ω to 600 Ω . Using a 220 μF capacitor as shown in Figure 12, the worst-case -3 dB corner frequency would be 22 Hz, with a 32 Ω headphone load. Smaller output capacitors could be used at the expense of low frequency response to the headphones.

An input coupling capacitor should be used to remove dc bias from the inputs to the SSM2250. Again, the input coupling capacitor in combination with the input resistor will create a high-pass filter with a corner frequency of:

$$f_{-3dB} = \frac{1}{2\pi R_{IC} C_1} \quad (3)$$

Using the values shown in Figure 2, where $R_1 = 20 \text{ k}\Omega$ and $C_1 = 1 \mu\text{F}$, will create a corner frequency of 8 Hz. This is acceptable, as the PC 99 audio requirement specifies the computer audio system bandwidth to be 20 Hz to 20 kHz.

Pin 10 on the SSM2250 provides the proper bias voltage for the amplifiers. A 0.1 μF capacitor should be connected here to reduce sensitivity to noise on the power supply. A larger capacitor can be used should more rejection from power supply noise be required.

The SSM2250 has excellent phase margin and is stable even under heavy loading. Therefore, a feedback capacitor in parallel with R_2 is not required, as it is in some competitors' products.

Power Dissipation

An important advantage in using a bridged output configuration is the fact that bridged output amplifiers are more efficient than single-ended amplifiers in delivering power to a load.

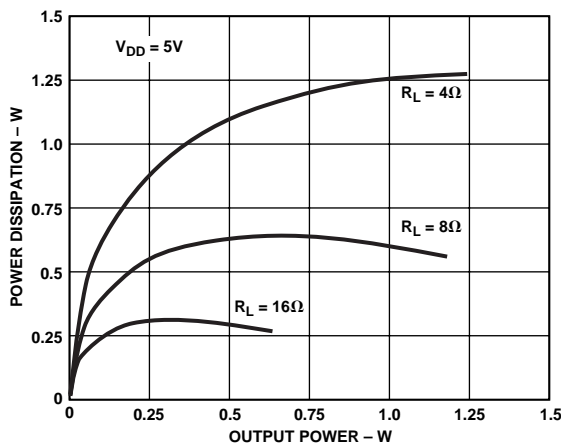

Figure 13. Power Dissipation vs. Output Power in BTL Mode

$$P_{DISS, MAX} = \frac{2V_{DD}^2}{\pi^2 R_L} \quad (4)$$

Using Equation 4 and the power derating curve in Figure 15, the maximum ambient temperature can be easily found. This ensures that the SSM2250 will not exceed its maximum junction temperature of 150°C.

The power dissipation for a single-ended output application where an output coupling capacitor is used is shown in Figure 14.

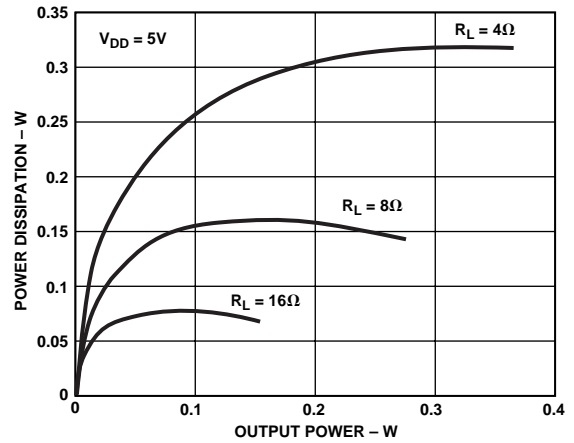

Figure 14. Power Dissipation vs. Single-Ended Output Power ($V_{DD} = 5 \text{ V}$)

The maximum power dissipation for a single-ended output is:

$$P_{DISS, MAX} = \frac{V_{DD}^2}{2\pi^2 R_L} \quad (5)$$

Because the SSM2250 is designed to drive two single-ended loads simultaneously, the worst-case maximum power dissipation in SE Mode is twice the value of Equation 5.

A thorough mathematical explanation behind Equation 4 and Equation 5 is given in the SSM2211 data sheet, which can be downloaded at <http://www.analog.com>.

Example: Given worst-case stereo headphone loads of 32 Ω , the maximum power dissipation of the SSM2250 in SE Mode with a 5 V supply would be:

$$P_{DISS, MAX} = \frac{(5 \text{ V})^2}{2\pi^2 32 \Omega} = 79 \text{ mW} \quad (6)$$

With an 8 Ω internal speaker attached, the maximum power dissipation in BTL mode is (from Equation 4):

$$P_{DISS, MAX} = \frac{2 \times (5 \text{ V})^2}{\pi^2 8 \Omega} = 633 \text{ mW} \quad (7)$$

It can be easily seen that power dissipation from BTL Mode operation is of greater concern than SE Mode.

Solving for Maximum Ambient Temperature

To protect the SSM2250 against thermal damage, the junction temperature of the die should not exceed 150°C. The maximum allowable ambient temperature of the application can be easily found by solving for the expected maximum power dissipation in Equation 4 and Equation 5, and using Equation 8.

SSM2250

Continuing from the previous example, the θ_{JA} of the SSM2250 14-lead TSSOP package on a 4-layer board is $140^{\circ}\text{C}/\text{W}$. To ensure the SSM2250 die junction temperature stays below 150°C , the maximum ambient temperature can be solved using Equation 8.

$$\begin{aligned} T_{\text{AMB, MAX}} &= +150^{\circ}\text{C} - \theta_{JA} \times P_{\text{DISS, MAX}} \\ &= +150^{\circ}\text{C} - (140^{\circ}\text{C}/\text{W} \times 0.633 \text{ W}) \quad (8) \\ &= +61^{\circ}\text{C} \end{aligned}$$

So the maximum ambient temperature must remain below 61°C to protect the device against thermal damage.

Another method for finding the maximum allowable ambient temperature is to use the power derating curve in Figure 15. The y-axis corresponds to the expected maximum power dissipation, and the x-axis is the corresponding maximum ambient temperature. Either method will return the same answer.

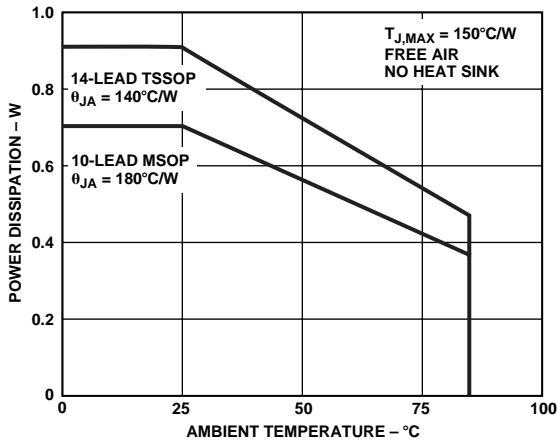

Figure 15. Maximum Power Dissipation vs. Ambient Temperature

Maximum Output Power

The maximum amount of power that can be delivered to a speaker is a function of the supply voltage and the resistance of the speaker. Figure 15 shows the maximum BTL output power possible from the SSM2250. Maximum output power is defined as the point at which the output has greater than 1% distortion.

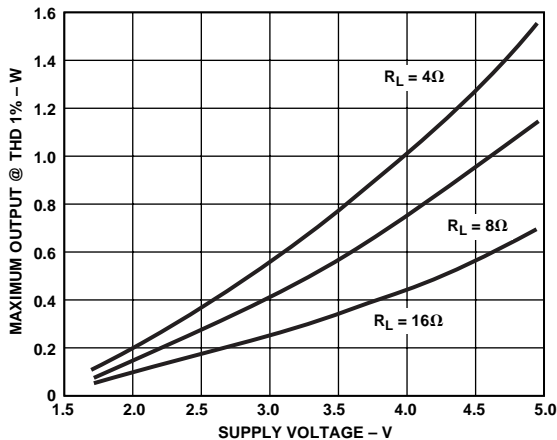

Figure 16. Maximum BTL Output Power vs. V_S

To find the minimum supply voltage needed to achieve a specified maximum undistorted output power, simply use Figure 16.

The output power in SE mode is exactly one-fourth the equivalent output power in BTL mode. This is because twice the voltage swing across the two BTL outputs results in $4\times$ the power delivered to the load. Figure 17 shows the maximum output power in SE mode vs. supply voltage for various headphone loads.

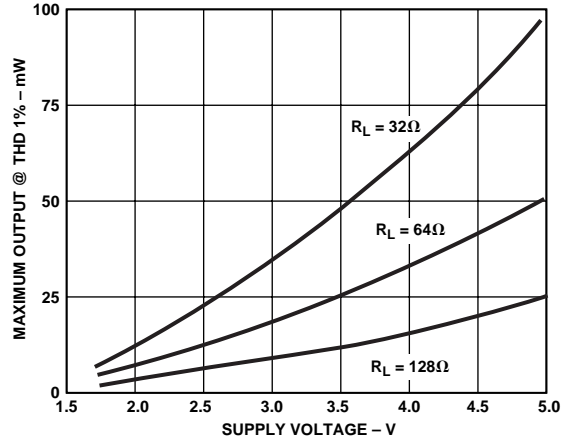

Figure 17. Maximum SE Output Power vs. V_S

Example: An application requires only 500 mW to be output in BTL Mode into an 8Ω speaker. By inspection, the minimum supply voltage required is 3.3 V.

Speaker Efficiency and Loudness

The effective loudness of 1 W of power delivered into an 8Ω speaker is a function of the efficiency of the speaker. The efficiency of a speaker is typically rated at the sound pressure level (SPL) at 1 meter in front of the speaker with 1 W of power applied to the speaker. Most speakers are between 85 dB and 95 dB SPL at one meter at 1 W of power. Table I shows a comparison of the relative loudness of different sounds.

Table I. Typical Sound Pressure Levels

Source of Sound	dB SPL
Threshold of Pain	120
Heavy Street Traffic	95
Cabin of Jet Aircraft	80
Average Conversation	65
Average Home at Night	50
Quiet Recording Studio	30
Threshold of Hearing	0

It can be easily seen that 1 W of power into a speaker can produce quite a bit of acoustic energy.

Shutdown Feature

The SSM2250 can be put into a low power consumption shutdown mode by connecting Pin 3 to V_{DD} . In shutdown mode, the SSM2250 has low supply current of $60 \mu\text{A}$.

Pin 3 should be connected to ground for normal operation. Connecting Pin 3 to V_{DD} will shut down all amplifiers and put all outputs into a high impedance state, effectively muting the SSM2250. A pull-up or pull-down resistor is not required. Pin 3 should never be left floating as this could produce unpredictable results.

PC 99 Compliant Computer Audio Reference Design

The schematic shown in Figure 18 is a reference design for a complete audio system in a computer. The design is compliant with the PC 99 standard for computer audio.

The AD1881 is an AC'97 Ver. 2.1 audio codec available from Analog Devices. The stereo output from the AD1881 is coupled into the SSM2250, which is used to drive a mono internal speaker and stereo headphones. The internal speaker switching is controlled by the SSM2250 through the normalizing pin on the headphone jack. The AD1881 controls the shutdown pin on the SSM2250, and is activated through the power management software drivers installed on the computer.

For more information on the AD1881, the data sheet can be downloaded from the Analog Devices web site at <http://www.analog.com>.

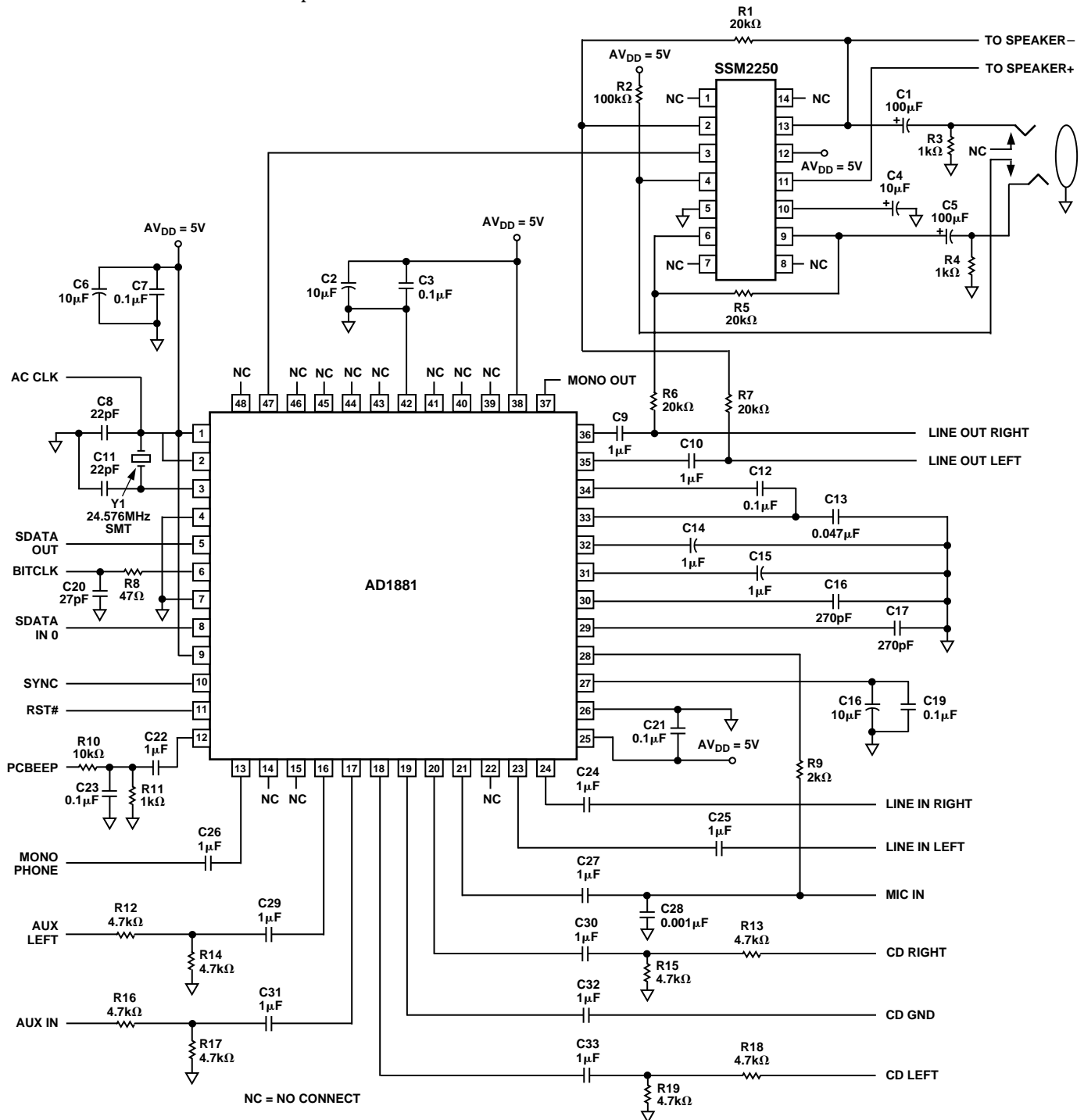

Figure 18. PC 99 Compliant Audio System Reference Design

SSM2250

OUTLINE DIMENSIONS

Dimensions shown in inches and (mm).

10-Lead MSOP (RM Suffix)

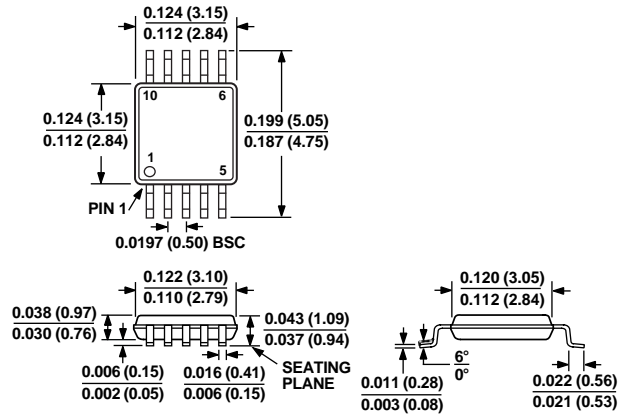

14-Lead TSSOP (RU Suffix)

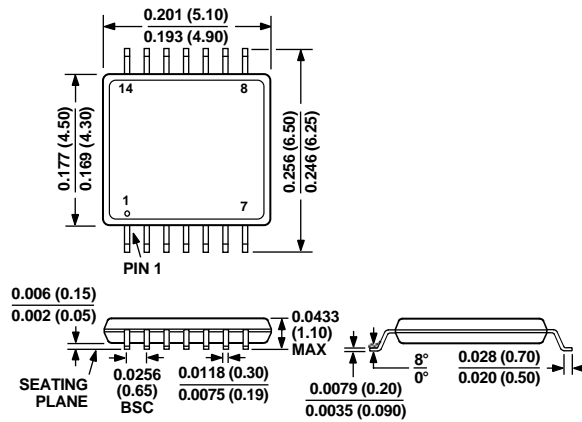

C3729-2.5-10/99

PRINTED IN U.S.A.